



Summit Plastic Company



Product Catalog 2023



Greenhouse division of:  NSI HOLDINGS Inc.

OUR MISSION

To provide innovative, high quality solutions that meet the needs of the horticultural container market.

3175 Gilchrist Rd
Mogadore, OH. 44260
Ph: 330.633.3668
Ph TF: 800.814.3496
www.summitplastic.com

Proudly Manufactured



In the USA

Let's get started.....

TABLE OF CONTENTS

JanorPot® Round containers and filling trays	4
3D Systems® containers and trays	23
Summit Square Systems	31
Customization	39
Propagation and liners	41
X-Line.....	45
Size Wise®	47
Slim Wise™	53
Eco 360® Rice Hull Containers	57





JānorPot® **Round Containers & Filling Trays**

Summit's JānorPot® brand of polypropylene round pot system is an innovative, automation friendly, and branding powerhouse. With the introduction of JānorPot®, Summit was the first to offer a full line of thermoformed, thin walled round pots produced in the United States. Proven European design features have made this system an outstanding favorite for automation, growing and branding. Featuring a smooth rolled lip with no sharp edges or projections, facilitating de-nesting and automation for larger scale growers.

Designed with a dual-drainage system to ensure optimal air/water exchange that maximizes plant growth potential. Each container is manufactured with two layers of polypropylene. The interior layer is produced with 100% reclaimed post-consumer plastic, and maintains the grower preferred black color to promote an ideal rooting environment at a better cost. The exterior layer may be customized with any eye-catching color imaginable to help draw attention to a grower's brand.

JānorPot® containers come in an array of colors and can be further customized with labeling and custom printing. Add simple bar codes to make inventory management easier, or print up to 8-color logos and artwork to fully illustrate your brand, merchandise it on the shelf, and drive brand recognition. Full color wrap printing helps display grower branding from any angle. Clean-punched tag slots are standard on select sizes for Big Box compatibility.

Summit's polystyrene filling trays perfectly match our line of round JānorPots® for a complete greenhouse plant potting system. Filling trays come in a wide variety of sizes and configurations to accommodate any number of unique grower needs. They are automation ready for easy filling, helping to reduce greenhouse labor costs.



9cmH

Dimensions	Dry Vol (cu. In.)	Liq Vol (U.S.)	Liq Vol (met)	Pots/ Ctn	Ctns/ Skid	Pots/ Gaylord	Full bulk Skid
3 9/16" dia. X 3 1/2" H	22.0	12.2fl oz.	360ml	2,340	16	30,420	n/a



9cmH-6 Filling Tray (minimum run item)

Dimensions	Trays/ Ctn	Ctns/ Skid	Full bulk Skid
10 9/16" X 7" X 3 5/8" H	200	48	9,600

**Features standard round handle holes*



9cmH-12 Filling Tray

Dimensions	Trays/ Ctn	Ctns/ Skid	Full bulk Skid
21" X 7" X 3 1/2" H	100	32	3,200



9cmH-18 Filling Tray

Dimensions	Trays/ Ctn	Ctns/ Skid	Full bulk Skid
21" X 10 1/2" X 3 1/2" H	50	48	2,400



JanorPot® Round Pot & Tray Systems

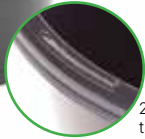

2 clean-punched tag slots

10cmT w/Tag Slots

Dimensions	Dry Vol (cu. In.)	Liq Vol (U.S.)	Liq Vol (met)	Pots/Ctn	Ctns/Skid	Pots/Gaylord	Full bulk Skid
3 15/16" dia. X 3 9/16" H	29.0	1.00pt	473ml	1,680	20	19,050	n/a



*Features standard round handle holes

10cmT-6 Filling Tray (minimum run item)

Dimensions	Trays/Ctn	Ctns/Skid	Full bulk Skid
11 7/8" X 8" X 3 3/4" H	200	44	8,800



10cmT-10 Filling Tray

Dimensions	Trays/Ctn	Ctns/Skid	Full bulk Skid
19 3/4" X 8" X 3 3/4" H	100	44	4,400

Customize me!
See page 39 & 40 for details





10.5cmH (Limited run item)

Dimensions	Dry Vol (cu. In.)	Liq Vol (U.S.)	Liq Vol (met)	Pots/Ctn	Ctns/Skid	Pots/Gaylord	Full bulk Skid
4 1/8" dia. X 3 9/16" H	32.1	1.11pt	525ml	1,300	20	14,960	n/a



10.5cmH-10 Filling Tray

Dimensions	Trays/Ctn	Ctns/Skid	Full bulk Skid
20 1/2" X 8" X 3 3/4" H	100	40	4,000



10.5cmH-15 Filling Tray (minimum run item)

Dimensions	Trays/Ctn	Ctns/Skid	Full bulk Skid
20 5/16" X 12 1/16" X 3 3/4" H	100	28	2,800



JanorPot® Round Pot & Tray Systems



11cmH

<i>Dimensions</i>	<i>Dry Vol (cu. In.)</i>	<i>Liq Vol (U.S.)</i>	<i>Liq Vol (met)</i>	<i>Pots/ Ctn</i>	<i>Ctns/ Skid</i>	<i>Pots/ Gaylord</i>	<i>Full bulk Skid</i>
4 3/8" dia. X 3 9/16" H	31.8	1.10pt	520ml	2,000	16	15,500	n/a



11cmH-10 Filling Tray

<i>Dimensions</i>	<i>Trays/ Ctn</i>	<i>Ctns/ Skid</i>	<i>Full bulk Skid</i>
21" X 7 1/4" X 3 1/2" H	100	36	3,600





11cmT w/Tag Slots

Dimensions	Dry Vol (cu. In.)	Liq Vol (U.S.)	Liq Vol (met)	Pots/Ctn	Ctns/Skid	Pots/Gaylord	Full bulk Skid
4 3/8" dia. X 5" H	47.4	1.64pt	776ml	1,625	16	15,500	n/a



2 clean-punched tag slots



11cmT-8 Filling Tray

Dimensions	Trays/Ctn	Ctns/Skid	Full bulk Skid
17" X 8 3/8" X 5 1/2" H	100	45	4,500



11cmT-10 Filling Tray

Dimensions	Trays/Ctn	Ctns/Skid	Full bulk Skid
21 1/2" X 8 1/2" X 5 1/4" H	100	30	4,000



11cmT-16 Filling Tray (Minimum run item)

Dimensions	Trays/Ctn	Ctns/Skid	Full bulk Skid
17" X 17" X 5 1/4" H	50	30	1,500



JanorPot® Round Pot & Tray Systems



12cmH

Dimensions	Dry Vol (cu. In.)	Liq Vol (U.S.)	Liq Vol (met)	Pots/Ctn	Ctns/Skid	Pots/Gaylord	Full bulk Skid
4 3/4" dia. X 3 15/16" H	45.6	1.58pt	748ml	1,425	16	12,900	n/a



12cmH-8 Filling Tray

Dimensions	Trays/Ctn	Ctns/Skid	Full bulk Skid
18 1/2" X 9" X 4 1/8" H	100	32	3,600



12cmH-8 Spaced Filling Tray

Dimensions	Trays/Ctn	Ctns/Skid	Full bulk Skid
20" X 10" X 4 1/8" H	100	32	3,200

**Features airflow holes*



12cmH-12 Filling Tray (Minimum run item)

Dimensions	Trays/Ctn	Ctns/Skid	Full bulk Skid
18 1/2" X 13 3/4" X 4 1/8" H	100	24	2,400



12cmH-15 Filling Tray (Minimum run item)

Dimensions	Trays/Ctn	Ctns/Skid	Full bulk Skid
23 5/16" X 13 3/4" X 4" H	50	30	1,800

JanorPot® Round Pot & Tray Systems

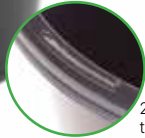

2 clean-punched tag slots

12cmT w/Tag Slots

Dimensions	Dry Vol (cu. In.)	Liq Vol (U.S.)	Liq Vol (met)	Pots/Ctn	Ctns/Skid	Pots/Gaylord	Full bulk Skid
4 3/4" dia. X 5" H	57.8	1.00qt	946ml	1,425	16	12,900	n/a



12cmT-8 Filling Tray

Dimensions	Trays/Ctn	Ctns/Skid	Full bulk Skid
18 1/2" X 9" X 5 1/4" H	100	24	3,600



12cmT-8 Staggered Filling Tray

Dimensions	Trays/Ctn	Ctns/Skid	Full bulk Skid
21" X 8 1/2" X 5 1/4" H	100	40	4,000



12cmT-10 Filling Tray

Dimensions	Trays/Ctn	Ctns/Skid	Full bulk Skid
23 1/4" X 9" X 5 1/4" H	100	30	4,000



12cmT-12 Filling Tray (Minimum run item)

Dimensions	Trays/Ctn	Ctns/Skid	Full bulk Skid
18 7/8" X 13 3/4" X 5 1/4" H	50	16	1,800



12cmT-3 Carry Tray

Dimensions	Trays/Ctn	Ctns/Skid	Full bulk Skid
14 1/2" X 4 3/4" X 3" H	200	24	4,800



JanorPot® Round Pot & Tray Systems



13cmH (limited run item)

<i>Dimensions</i>	<i>Dry Vol (cu. In.)</i>	<i>Liq Vol (U.S.)</i>	<i>Liq Vol (met)</i>	<i>Pots/ Ctn</i>	<i>Ctns/ Skid</i>	<i>Pots/ Gaylord</i>	<i>Full bulk Skid</i>
5 1/8" dia. X 4 13/16" H	57.8	1.06qt	1.00L	960	16	9,180	n/a



13cmH-6 Filling Tray (minimum run item)

<i>Dimensions</i>	<i>Trays/ Ctn</i>	<i>Ctns/ Skid</i>	<i>Full bulk Skid</i>
15 1/4" X 10 1/4" X 5" H	100	36	3,600



13cmH-8 Filling Tray

<i>Dimensions</i>	<i>Trays/ Ctn</i>	<i>Ctns/ Skid</i>	<i>Full bulk Skid</i>
20" X 10" X 5" H	50	48	2,400



14cmT

<i>Dimensions</i>	<i>Dry Vol (cu. In.)</i>	<i>Liq Vol (U.S.)</i>	<i>Liq Vol (met)</i>	<i>Pots/ Ctn</i>	<i>Ctns/ Skid</i>	<i>Pots/ Gaylord</i>	<i>Full bulk Skid</i>
5 1/2" dia. X 4 7/16" H	72.2	1.25qt	1.18L	800	16	7,560	n/a



14cmT-8 Filling Tray

<i>Dimensions</i>	<i>Trays/ Ctn</i>	<i>Ctns/ Skid</i>	<i>Full bulk Skid</i>
22" X 11" X 4 5/8" H	50	48	2,400





JanorPot® Round Pot & Tray Systems



1 clean-punched tag slot

15cmT* w/Tag Slot

Dimensions	Dry Vol (cu. In.)	Liq Vol (U.S.)	Liq Vol (met)	Pots/ Ctn	Ctns/ Skid	Pots/ Gaylord	Full bulk Skid
5 15/16" dia. X 4 1/2" H	75.7	1.31qt	1.24L	600	16	6,095	n/a

*Formerly our 15cmL, the new 15cmT features a shoulderless design—allowing more usable pot area for labeling and printing. Dimensions and volumes remain the same.



15cmT-6 Filling Tray

Dimensions	Trays/ Ctn	Ctns/ Skid	Full bulk Skid
18" X 11 1/2" X 4 1/2" H	50	42	2,100



16cmT-3 Filling Tray

Dimensions	Trays/ Ctn	Ctns/ Skid	Full bulk Skid
18 7/8" X 6 5/16" X 4 1/2" H	100	32	5,600

Customize me!
See page 39 & 40 for details



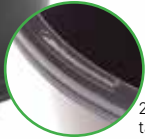

2 clean-punched tag slots

16cmL w/Tag Slots (limited run item)

Dimensions	Dry Vol (cu. In.)	Liq Vol (U.S.)	Liq Vol (met)	Pots/Ctn	Ctns/Skid	Pots/Gaylord	Full bulk Skid
6 1/4" dia. X 5 9/16" H	115.5	2.0qt	1.90L	385	16	3,570	10,780



16cmL-6 Filling Tray (limited run item)

Dimensions	Trays/Ctn	Ctns/Skid	Full bulk Skid
18 3/8" X 12 1/8" X 5 3/4" H	50	32	1600



Handler™ MT 62

Dimensions	Trays/Ctn	Ctns/Skid	Full bulk Skid
18 3/4" X 12 1/2" X 2 1/2" H	50	42	2,450



Handler™ IM 62 (Injection Molded)

Dimensions	Trays/Ctn	Ctns/Skid	Full bulk Skid
18 7/8" X 12 9/16" X 3 1/2" H	n/a	n/a	1,400



16cmT-3 Filling Tray

Dimensions	Trays/Ctn	Ctns/Skid	Full bulk Skid
18 7/8" X 6 5/16" X 4 1/2" H	100	32	5,600



JanorPot® Round Pot & Tray Systems



16cmT w/Tag Slots

Dimensions	Dry Vol (cu. In.)	Liq Vol (U.S.)	Liq Vol (met)	Pots/Ctn	Ctns/Skid	Pots/Gaylord	Full bulk Skid
6 1/4" dia. X 6 3/4" H	144.4	2.50qt	2.37L	385	16	4,410	10,535



2 clean-punched tag slots



16cmT-6 Filling Tray

Dimensions	Trays/Ctn	Ctns/Skid	Full bulk Skid
19" X 12 3/4" X 6 7/8" H	50	28	1,600



Handler™ MT 62

Dimensions	Trays/Ctn	Ctns/Skid	Full bulk Skid
18 3/4" X 12 1/2" X 2 1/2" H	50	42	2,450



Handler™ IM 62 (Injection Molded)

Dimensions	Trays/Ctn	Ctns/Skid	Full bulk Skid
18 7/8" X 12 9/16" X 3 1/2" H	n/a	n/a	1,400



16cmT-3 Filling Tray

Dimensions	Trays/Ctn	Ctns/Skid	Full bulk Skid
18 7/8" X 6 5/16" X 4 1/2" H	100	32	5,600



17cmL (limited run item)

<i>Dimensions</i>	<i>Dry Vol (cu. In.)</i>	<i>Liq Vol (U.S.)</i>	<i>Liq Vol (met)</i>	<i>Pots/Ctn</i>	<i>Ctns/Skid</i>	<i>Pots/Gaylord</i>	<i>Full bulk Skid</i>
6 11/16" dia X 4 15/16" H	122.0	2.11qt	2.00L	414	16	3,895	9,660



17cmL-6 Filling Tray (minimum run item)

<i>Dimensions</i>	<i>Trays/Ctn</i>	<i>Ctns/Skid</i>	<i>Full bulk Skid</i>
19 13/16" X 13 1/16" X 5 3/16" H	50	36	1,800



Handler™ MT 63

<i>Dimensions</i>	<i>Trays/Ctn</i>	<i>Ctns/Skid</i>	<i>Full bulk Skid</i>
18 3/4" X 13" Xv2" H	50	32	2,100



Handler™ 33

<i>Dimensions</i>	<i>Trays/Ctn</i>	<i>Ctns/Skid</i>	<i>Full bulk Skid</i>
19 3/4" X 6 1/2" X 3" H	100	32	3,600



JanorPot® Round Pot & Tray Systems



17cmH

<i>Dimensions</i>	<i>Dry Vol (cu. In.)</i>	<i>Liq Vol (U.S.)</i>	<i>Liq Vol (met)</i>	<i>Pots/ Ctn</i>	<i>Ctns/ Skid</i>	<i>Pots/ Gaylord</i>	<i>Full bulk Skid</i>
6 11/16" dia. X 6 1/8" H	158.8	2.75qt	2.60L	360	16	3,690	9,660



17cmH-6 Filling Tray

<i>Dimensions</i>	<i>Trays/ Ctn</i>	<i>Ctns/ Skid</i>	<i>Full bulk Skid</i>
20" X 16 1/4" X 6 1/4" H	50	24	1,800



Handler™ MT 63

<i>Dimensions</i>	<i>Trays/ Ctn</i>	<i>Ctns/ Skid</i>	<i>Full bulk Skid</i>
18 3/4" X 13" Xv2" H	50	32	2,100



Handler™ 33

<i>Dimensions</i>	<i>Trays/ Ctn</i>	<i>Ctns/ Skid</i>	<i>Full bulk Skid</i>
19 3/4" X 6 1/2" X 3" H	100	32	3,600

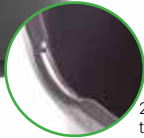

19cmXL w/Tag Slots (limited run item)

Dimensions	Dry Vol (cu. In.)	Liq Vol (U.S.)	Liq Vol (met)	Pots/Ctn	Ctns/Skid	Pots/Gaylord	Full bulk Skid
7 1/2" dia. X 5" H	151.8	2.63qt	2.49L	360	16	2,400	8,640

2 clean-punched tag slots



19cmXL-3 Filling Tray

Dimensions	Trays/Ctn	Ctns/Skid	Full bulk Skid
22 1/8" X 7 3/16" X 5" H	100	36	3,600



Handler™ 64

Dimensions	Trays/Ctn	Ctns/Skid	Full bulk Skid
21" X 15" X 2 1/2" H	50	18	1,200



Handler™ MT 64

Dimensions	Trays/Ctn	Ctns/Skid	Full bulk Skid
21 7/16" X 14" X 3" H	50	24	1,200



JanorPot[®] Round Pot & Tray Systems



19cmL w/Tag Slots

Dimensions	Dry Vol (cu. In.)	Liq Vol (U.S.)	Liq Vol (met)	Pots/Ctn	Ctns/Skid	Pots/Gaylord	Full bulk Skid
7 1/2" dia. X 6" H	173.3	3.00qt	2.84L	360	16	2,580	8,640

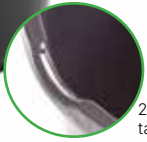

2 clean-punched tag slots



Handler™ 64

Dimensions	Trays/Ctn	Ctns/Skid	Full bulk Skid
21" X 15" X 2 1/2" H	50	18	1,200



Handler™ MT 64

Dimensions	Trays/Ctn	Ctns/Skid	Full bulk Skid
21 7/16" X 14" X 3" H	50	24	1,200

See page 39 & 40 for details



Customize me!

JanorPot[®] Round Pot & Tray Systems



19cmT w/Tag Slots

Dimensions	Dry Vol (cu. In.)	Liq Vol (U.S.)	Liq Vol (met)	Pots/Ctn	Ctns/Skid	Pots/Gaylord	Full bulk Skid
7 1/2" dia. X 7 1/4" H	231.0	1.00gal	3.79L	270	16	2,400	7,200



2 clean-punched tag slots



Handler™ 64

Dimensions	Trays/Ctn	Ctns/Skid	Full bulk Skid
21" X 15" X 2 1/2" H	50	18	1,200



Handler™ MT 64

Dimensions	Trays/Ctn	Ctns/Skid	Full bulk Skid
21 7/16" X 14" X 3" H	50	24	1,200





JanorPot[®] Round Pot & Tray Systems



22cmL (limited run item)

<i>Dimensions</i>	<i>Dry Vol (cu. In.)</i>	<i>Liq Vol (U.S.)</i>	<i>Liq Vol (met)</i>	<i>Pots/ Ctn</i>	<i>Ctns/ Skid</i>	<i>Pots/ Gaylord</i>	<i>Full bulk Skid</i>
8 5/8" dia X 6" H	277.2	1.2gal	4.54L	150	16	1,955	n/a



22cmT w/Tag Slot

<i>Dimensions</i>	<i>Dry Vol (cu. In.)</i>	<i>Liq Vol (U.S.)</i>	<i>Liq Vol (met)</i>	<i>Pots/ Ctn</i>	<i>Ctns/ Skid</i>	<i>Pots/ Gaylord</i>	<i>Full bulk Skid</i>
8 5/8" dia X 7 7/8" H	346.5	1.5gal	5.68L	150	16	1,955	n/a

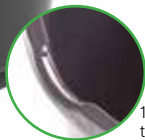

1 clean-punched
tag slot





How can Summit's 3D Systems technology benefit your operation?

3D Systems® container and filling tray systems were carefully designed to provide advantages in greenhouse production, retail and branding— saving you time, money and ensuring branding/retail info is front-faced. Remember the 3 “D”s:

Direction • Dimension • Display



Tagging

Direction Direction Direction Direction Direction Direction
 Direction Direction Direction Direction Direction Direction
 Direction Direction Direction Direction Direction Direction

Take advantage of better efficiency in tagging!
 As the 3D Systems® container only fits in its tray one way, the tag slot is always right where you need it— Front and center. Clean-punched tag slots make insertion fast and easy.



Labeling

Direction Direction Direction Direction Direction Direction
 Direction Direction Direction Direction Direction Direction
 Direction Direction Direction Direction Direction Direction

A labeling dynamo!
 For labeling operations, low rider trays offer plenty of space for on-site application — or have Summit pre-label your product! Once inserted into the tray the label automatically faces forward, for avd consistent merchandising look on the rack that stays put. Additionally, the sides and rear of the container can accept labels for increased flexibility!



Branding/Decorating

Display Display Display Display
 Display Display Display Display
 Display Display Display Display

The flat face of the container can accept large adhesives, offering you:

- Large brand messaging
- High quality flexographic printing
- Options for creative effects and materials that grab attention
- Longer UV resistance compared to standard container printing
- Label capability on front AND back of container



Space Savings

Dimension Dimension Dimension Dimension
 Dimension Dimension Dimension Dimension
 Dimension Dimension Dimension Dimension

Space savings, galore!
 Maximize the product on your racks with 3D Systems® compared to round pots. Depending on the container size and your racks, 3D Systems® can help you acheive **up to 50% more product on your racks and on the bench.**



Options

Direction Dimension Display Direction Dimension Dis-
 play Direction Dimension Display Direction Dimension
 Display Direction Dimension Display Direction Dimen-

3D Systems® containers are available in 1 pint, 1.25 pint, 1.5 pint, 1 quart, 1.25 quart, 2 quart and 2.5 quart. Trays for select sizes can be purchased in a side-facing or end-facing configuration, depending on your requirements.



clean-punched tag slot

3D Systems[®] 1 Pint w/Tag Slot

Dimensions	Dry Vol (cu. In.)	Liq Vol (U.S.)	Liq Vol (met)	Pots/Ctn	Ctns/Skid	Pots/Gaylord	Full bulk Skid
3 1/2" X 3 1/2" X 3 7/8" H	29.0	1.00pt	473mL	1,440	16	12,870	n/a



3D 1 Pint-12 Filling Tray

Dimensions	Trays/Ctn	Ctns/Skid	Full bulk Skid
21" X 7" X 4 5/32" H	100	n/a	3,600



3D 1 Pint- 12 Filling Tray (end-facing) Injection Molded

Dimensions	Trays/Ctn	Ctns/Skid	Full bulk Skid
20 3/4" X 6 5/8" X 2" H	n/a	n/a	1,500



3D Systems® Containers & Trays



clean-punched tag slot

3D Systems® 1.25 Pint w/Tag Slot

Dimensions	Dry Vol (cu. In.)	Liq Vol (U.S.)	Liq Vol (met)	Pots/Ctn	Ctns/Skid	Pots/Gaylord	Full bulk Skid
3.5" X 3.5" X 4.95" H	36.1	1.25pt	592mL	1,440	16	12,870	n/a



3D 1.25 Pint-10 Filling Tray

Dimensions	Trays/Ctn	Ctns/Skid	Full bulk Skid
17.5" X 7" X 5.1" H	50	n/a	2,400

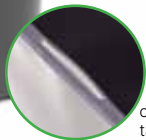

clean-punched tag slot

3D Systems® 1.50 Pint w/Tag Slot

Dimensions	Dry Vol (cu. In.)	Liq Vol (U.S.)	Liq Vol (met)	Pots/Ctn	Ctns/Skid	Full bulk Skid
3.9" X 3.6" X 5.6" H	43.3	1.50pt	709mL	TBD	TBD	12,000



3D 1.50 Pint-10 Filling Tray

Dimensions	Trays/Ctn	Ctns/Skid	Full bulk Skid
20" X 7.2" X 5.79" H	50	n/aaa	2,400

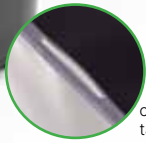

clean-punched tag slot

3D Systems® 1 Quart w/Tag Slot

Dimensions	Dry Vol (cu. In.)	Liq Vol (U.S.)	Liq Vol (met)	Pots/Ctn	Ctns/Skid	Pots/Gaylord	Full bulk Skid
4 1/8" X 4 3/8" X 5 1/2" H	57.8	1.00qt	946mL	900	16	8,910	n/a



3D 1 Quart-10 Filling Tray

Dimensions	Trays/Ctn	Ctns/Skid	Full bulk Skid
20 26/32 X 8 1/2" X 5 26/32" H	100	n/a	2,000



3D 1 Quart- 10 Filling Tray (end-facing) Injection Molded

Dimensions	Trays/Ctn	Ctns/Skid	Full bulk Skid
21 5/8" X 8" X 2" H	n/a	n/a	2,000

Customize me!
See page 39 & 40 for details





3D Systems® Containers & Trays



3D Systems® 1.25 Quart

<i>Dimensions</i>	<i>Dry Vol (cu. In.)</i>	<i>Liq Vol (U.S.)</i>	<i>Liq Vol (met)</i>	<i>Pots/ Ctn</i>	<i>Ctns/ Skid</i>	<i>Pots/ Gaylord</i>	<i>Full bulk Skid</i>
4 3/4" X 4 3/4" X 6 1/4" H	72.2	1.25qt	1.18L	900	16	9,200	n/a



3D 1.25 Quart-8 Filling Tray

<i>Dimensions</i>	<i>Trays/ Ctn</i>	<i>Ctns/ Skid</i>	<i>Full bulk Skid</i>
18 3/8" X 9" X 5" H	n/a	n/a	2,700



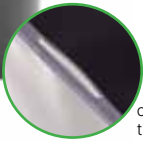

clean-punched tag slot

3D Systems[®] 2 Quart w/Tag Slot

Dimensions	Dry Vol (cu. In.)	Liq Vol (U.S.)	Liq Vol (met)	Pots/Ctn	Ctns/Skid	Pots/Gaylord	Full bulk Skid
5 3/4" X 5 3/4" X 6" H	115.5	2.0qt	1.90L	400	16	3,472	N/a



3D 2.5 Quart-6 Filling Tray (side-facing) Injection Molding

Dimensions	Trays/Ctn	Ctns/Skid	Full bulk Skid
18 X 11 1/8" X 5 1/16" H	n/a	n/a	1,600



3D 2.5 Quart-6 Filling Tray (end-facing) Injection Molding

Dimensions	Trays/Ctn	Ctns/Skid	Full bulk Skid
17 3/8" X 11 1/4" X 2" H	n/a	n/a	1,600



3D Systems® Containers & Trays



3D Systems® 2.5 Quart w/Tag Slot

Dimensions	Dry Vol (cu. In.)	Liq Vol (U.S.)	Liq Vol (met)	Pots/Ctn	Ctns/Skid	Pots/Gaylord	Full bulk Skid
5 3/4" X 5 3/4" X 7 1/8" H	144.4	2.50qt	2.37L	400	16	3,472	n/a

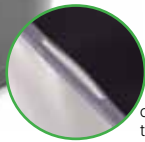

clean-punched tag slot



3D 2.5 Quart-6 Filling Tray (side-facing) Injection Molded

Dimensions	Trays/Ctn	Ctns/Skid	Full bulk Skid
18 X 11 1/8" X 5 1/16" H	n/a	n/a	1,600



3D 2.5 Quart-6 Filling Tray (end-facing) Injection Molded

Dimensions	Trays/Ctn	Ctns/Skid	Full bulk Skid
17 3/8" X 11 1/4" X 2 1/2" H	n/a	n/a	1,600



SQUARE SYSTEMS

Our square greenhouse pots have become an industry standard with people asking for them by name! The side-fluted NuPots™ offer side and bottom drainage, a Summit innovation that minimizes root circling. Our trademarked Duo™ manufacturing process allows us to offer NuPots™ in a wide range of plant pot colors. And now Summit offers tag slots on our full-pint and full-quart NuPot™ IP pots.

Using our Duo™ manufacturing process, we are able to offer our smooth-sided square pots in a wide range of colors. Square pot systems are an especially popular choice with space-conscious growers, as they can maximize rack space for more efficient shipping.

They are time tested, and grower approved!





Square Systems Containers and Trays



Nu Pot™ 3

<i>Dimensions</i>	<i>Dry Vol (cu. In.)</i>	<i>Liq Vol (U.S.)</i>	<i>Liq Vol (met)</i>	<i>Pots/ Ctn</i>	<i>Ctns/ Skid</i>	<i>Pots/ Gaylord</i>	<i>Full bulk Skid</i>
2 5/8" SQ X 3 1/2" H	14.0	7.8oz	231ml	2,500	24	n/a	n/a



Nu Tray™ 3-32

<i>Dimensions</i>	<i>Trays/ Ctn</i>	<i>Ctns/ Skid</i>	<i>Full bulk Skid</i>
21" X 10 1/2" X 2 1/2" H	80	32	2,400





Nu Pot™ 4

<i>Dimensions</i>	<i>Dry Vol (cu. In.)</i>	<i>Liq Vol (U.S.)</i>	<i>Liq Vol (met)</i>	<i>Pots/ Ctn</i>	<i>Ctns/ Skid</i>	<i>Pots/ Gaylord</i>	<i>Full bulk Skid</i>
3 1/4" SQ X 3 7/8" H	25.8	14.3oz	423ml	1,600	24	23,660	n/a



Nu Tray™ 4-6 (minimum run item)

<i>Dimensions</i>	<i>Trays/ Ctn</i>	<i>Ctns/ Skid</i>	<i>Full bulk Skid</i>
9 13/16" X 6 1/2" X 2 1/2" H	260	32	8,320



Nu Tray™ 4-12

<i>Dimensions</i>	<i>Trays/ Ctn</i>	<i>Ctns/ Skid</i>	<i>Full bulk Skid</i>
19 5/8" X 6 3/4" X 2" H	130	36	4,680



Nu Tray™ 4-16 (minimum run item)

<i>Dimensions</i>	<i>Trays/ Ctn</i>	<i>Ctns/ Skid</i>	<i>Full bulk Skid</i>
13 1/4" X 13 1/4" X 3 1/4" H	100	24	2,400



Nu Tray™ 4-18

<i>Dimensions</i>	<i>Trays/ Ctn</i>	<i>Ctns/ Skid</i>	<i>Full bulk Skid</i>
19 1/2" X 10" X 2" H	90	32	2,880



Square Systems Containers and Trays



Nu Pot™ 4 IP w/Tag Slots

Dimensions	Dry Vol (cu. In.)	Liq Vol (U.S.)	Liq Vol (met)	Pots/Ctn	Ctns/Skid	Pots/Gaylord	Full bulk Skid
3 1/4" SQ X 3 7/8" H	28.88	1.00pt	473mL	1,600	24	20,930	n/a



Nu Tray™ 4-6 (minimum run item)

Dimensions	Trays/Ctn	Ctns/Skid	Full bulk Skid
9 13/16" X 6 1/2" X 2 1/2" H	260	32	8,320



Nu Tray™ 4-12

Dimensions	Trays/Ctn	Ctns/Skid	Full bulk Skid
19 5/8" X 6 3/4" X 2" H	130	36	4,680



Nu Tray™ 4-16 (minimum run item)

Dimensions	Trays/Ctn	Ctns/Skid	Full bulk Skid
13 1/4" X 13 1/4" X 3 1/4" H	100	24	2,400



Nu Tray™ 4-18

Dimensions	Trays/Ctn	Ctns/Skid	Full bulk Skid
19 1/2" X 10" X 2" H	90	32	2,880



Nu Pot™ 5

<i>Dimensions</i>	<i>Dry Vol (cu. In.)</i>	<i>Liq Vol (U.S.)</i>	<i>Liq Vol (met)</i>	<i>Pots/ Ctn</i>	<i>Ctns/ Skid</i>	<i>Pots/ Gaylord</i>	<i>Full bulk Skid</i>
4 3/8" SQ X 4 3/4" H	57.8	1.0qt	946ml	450	48	n/a	n/a



Nu Tray™ 5-10

<i>Dimensions</i>	<i>Trays/ Ctn</i>	<i>Ctns/ Skid</i>	<i>Full bulk Skid</i>
22" X 8 3/4" X 2 1/2" H	90	40	3,600



Nu Tray™ 5-12 (minimum run item)

<i>Dimensions</i>	<i>Trays/ Ctn</i>	<i>Ctns/ Skid</i>	<i>Full bulk Skid</i>
17 1/2" X 13" X 3 1/4" H	75	32	2,700



Nu Tray™ 5-15 (minimum run item)

<i>Dimensions</i>	<i>Trays/ Ctn</i>	<i>Ctns/ Skid</i>	<i>Full bulk Skid</i>
22" X 13" X 3 1/4" H	60	36	2,160



Square Systems Containers and Trays



Nu Pot™ 5 IP w/Tag Slots

Dimensions	Dry Vol (cu. In.)	Liq Vol (U.S.)	Liq Vol (met)	Pots/ Ctn	Ctns/ Skid	Pots/ Gaylord	Full bulk Skid
4 3/8" SQ X 4 3/4" H	57.8	1.0qt	946ml	450	48	9,000	n/a



Nu Tray™ 5-10

Dimensions	Trays/ Ctn	Ctns/ Skid	Full bulk Skid
22" X 8 3/4" X 2 1/2" H	90	40	3,600



Nu Tray™ 5-12 (minimum run item)

Dimensions	Trays/ Ctn	Ctns/ Skid	Full bulk Skid
17 1/2" X 13" X 3 1/4" H	75	32	2,700



Nu Tray™ 5-15 (minimum run item)

Dimensions	Trays/ Ctn	Ctns/ Skid	Full bulk Skid
22" X 13" X 3 1/4" H	60	36	2,160



Nu Pot™ 5 Squat

<i>Dimensions</i>	<i>Dry Vol (cu. In.)</i>	<i>Liq Vol (U.S.)</i>	<i>Liq Vol (met)</i>	<i>Pots/ Ctn</i>	<i>Ctns/ Skid</i>	<i>Pots/ Gaylord</i>	<i>Full bulk Skid</i>
4 3/8" SQ X 3 11/16" H	43.3	1.5pt	710ml	450	48	N/a	n/a



Nu Tray™ 5-10

<i>Dimensions</i>	<i>Trays/ Ctn</i>	<i>Ctns/ Skid</i>	<i>Full bulk Skid</i>
22" X 8 3/4" X 2 1/2" H	90	40	3,600



Nu Tray™ 5-12 (minimum run item)

<i>Dimensions</i>	<i>Trays/ Ctn</i>	<i>Ctns/ Skid</i>	<i>Full bulk Skid</i>
17 1/2" X 13" X 3 1/4" H	75	32	2,700



Nu Tray™ 5-15 (minimum run item)

<i>Dimensions</i>	<i>Trays/ Ctn</i>	<i>Ctns/ Skid</i>	<i>Full bulk Skid</i>
22" X 13" X 3 1/4" H	60	36	2,160



Square Systems Containers and Trays



4" Square Quart

Dimensions	Dry Vol (cu. In.)	Liq Vol (U.S.)	Liq Vol (met)	Pots/ Ctn	Ctns/ Skid	Pots/ Gaylord	Full bulk Skid
4" sq. X 4 3/4" H	57.8	1.0qt	946ml	500	40	N/a	N/a



4" Square qt - 10 Tray

Dimensions	Trays/ Ctn	Ctns/ Skid	Full bulk Skid
20" X 8" X 2 1/2"H	50	44	2,200



2 Quart Square



Dimensions	Dry Vol (cu. In.)	Liq Vol (U.S.)	Liq Vol (met)	Pots/ Ctn	Ctns/ Skid	Pots/ Gaylord	Full bulk Skid
5 3/8" sq. X 6 1/2" H	115.5	2.0qt	1.90L	480	16	4,200	N/a



2 Quart Square-8 Tray

Dimensions	Trays/ Ctn	Ctns/ Skid	Full bulk Skid
21" X 10 3/8" X 3 5/8" H	100	32	2,400

Custom SERVICES

Dry-Offset PRINTING

Summit Plastic brought thin-wall thermoformed container printing to the horticulture market, after the introduction of our JanorPot® brand containers nearly 20 years ago. During this time, we've partnered with brands, breeders, retailers and growers to develop successful, long term programs, that drive sales. Our industry-leading print department and designers will guide your project from concept through pre-flight and to production, consulting with you throughout the process to deliver a high-quality, high-impact look, which promotes your branding and marketing initiatives. Design and mockup services are offered to help bring your ideas to life and help sell.



LABELING

Summit Plastic Company offers labeling application services that range from simple, small UPC barcodes, to large, decorative, branded labels that can make your packaging shine! Labels have a UV resistance that can outlast printing and provide flexibility and uniqueness to match your creativity. From advanced materials that can enhance your packaging with eye-catching effects, to peel-away options that can eliminate the need for tags, or be used for coupon strategies—The possibilities are endless!



TOOLING

Have an idea for a product that is not offered in the market or need to tweak an existing product? Summit Plastic Company can help! Our team of engineering and tooling experts—with over 100 years of combined experience in mold-making for the horticulture industry can work with you to design your custom product— From drawings to renderings to prototype and through to production.

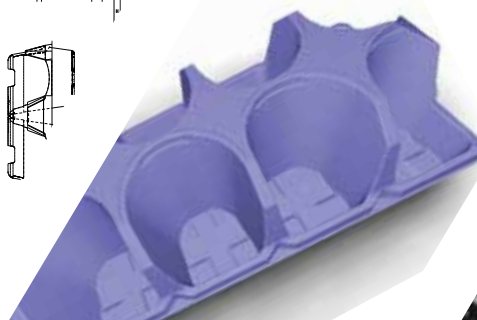
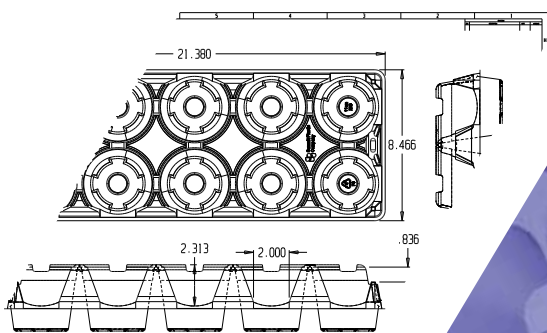

Customize Your COLOR

We offer our duo® (black interior, color exterior) JanorPot® containers in an array of established colors and the ability to custom formulate any color to meet your specification. Use colors to promote your brand, to match the flowering variety, or to indicate price points or programs at retail or in production. **Ask us how we can help develop your unique color program!**



Minimums:

Standard Colors = n/a (\$500 minimum order),

Specialty Colors= 30,000/Color 10cmT-19cmT | 11,730/Color 22cmT. Smaller orders can be combined with larger production runs as it fits into production schedules.

Custom Colors= 300,000

9cmH Only available in standard colors



Propagation & Liners

Uniquely designed to promote optimal root structure and growth, take a close look at Summit Plastic Company's **Root Tutor™** and **Root Stepper™** propagation/plug trays to see how they can benefit your crop production.

Root Tutors™ feature star-patterned internal channels force root direction down to meet the large bottom holes to stimulate air-pruning. Bottom holes are cleanly and fully punched for best use in automation equipment.

Root Steppers™ are designed to enhance development of roots, especially the very fine roots necessary to promote absorption of water and micronutrients. The stepped design causes roots to develop into the soil mass instead of circling the cell wall which leads to a large root mass for speedier plant development when placed in larger containers or in the garden.

Rounding out our line of landscape products are our **liners**, which provide an economical starting point for annuals, foliage and woody plants. Available in a variety of cell configurations and features, including fluted cells and community watering channels.





Propagation Trays



Root Tutor™ #21

Dimensions	Dry Vol (cu. In.)	Liq Vol (U.S.)	Liq Vol (met)	Tray/ Ctn	Ctns/ Skid	Full bulk Skid
21" X 10 3/4" X 3 7/8" H	323.4	1.40gal	5.30L	50	32	2,400

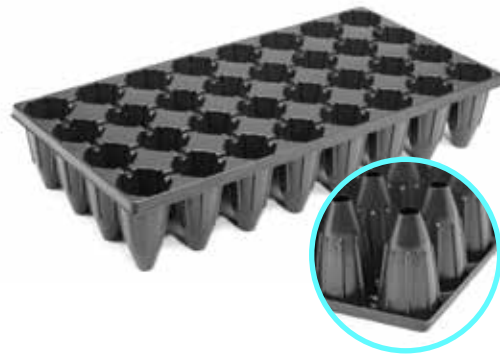

Root Tutor™ #32

Dimensions	Dry Vol (cu. In.)	Liq Vol (U.S.)	Liq Vol (met)	Tray/ Ctn	Ctns/ Skid	Full bulk Skid
21" X 10 1/2" X 4" H	311.9	1.35gal	5.11L	50	32	1,600



Root Tutor™ #72

Dimensions	Dry Vol (cu. In.)	Liq Vol (U.S.)	Liq Vol (met)	Tray/ Ctn	Ctns/ Skid	Full bulk Skid
21" X 10 1/2" X 3 1/4" H	277.2	1.20gal	4.54L	50	32	1,600



Root Stepper™ 18

<i>Dimensions</i>	<i>Dry Vol (cu. In.)</i>	<i>Liq Vol (U.S.)</i>	<i>Liq Vol (met)</i>	<i>Tray/ Ctn</i>	<i>Ctns/ Skid</i>	<i>Full bulk Skid</i>
20" X 10" X 3 5/8" H	330.3	1.43gal	5.41L	100	24	2,400

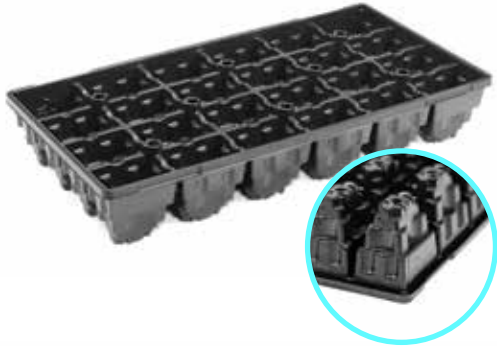

Root Stepper™ 24

<i>Dimensions</i>	<i>Dry Vol (cu. In.)</i>	<i>Liq Vol (U.S.)</i>	<i>Liq Vol (met)</i>	<i>Tray/ Ctn</i>	<i>Ctns/ Skid</i>	<i>Full bulk Skid</i>
20" X 10" X 3 1/4" H	365.0	1.58gal	5.98L	100	28	2,800



24 Cell Plug Tray

<i>Dimensions</i>	<i>Dry Vol (cu. In.)</i>	<i>Liq Vol (U.S.)</i>	<i>Liq Vol (met)</i>	<i>Tray/ Ctn</i>	<i>Ctns/ Skid</i>	<i>Full bulk Skid</i>
21" X 10 1/2" X 2 1/2" H	251.8	1.09gal	4.13L	100	24	2,400



128 Cell Plug Tray

<i>Dimensions</i>	<i>Dry Vol (cu. In.)</i>	<i>Liq Vol (U.S.)</i>	<i>Liq Vol (met)</i>	<i>Tray/ Ctn</i>	<i>Ctns/ Skid</i>	<i>Full bulk Skid</i>
21" X 10 1/2" X 2 3/8" H	254.1	1.10gal	4.16L	100	40	3,200



Propagation Trays



2401 Liner

<i>Dimensions</i>	<i>Dry Vol (cu. In.)</i>	<i>Liq Vol (U.S.)</i>	<i>Liq Vol (met)</i>	<i>Tray/ Ctn</i>	<i>Ctns/ Skid</i>	<i>Full bulk Skid</i>
21" X 10 1/2" X 2 3/8" H	293.4	1.27gal	4.81L	100	40	5,000

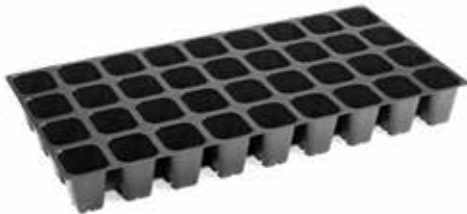

3601 Liner

<i>Dimensions</i>	<i>Dry Vol (cu. In.)</i>	<i>Liq Vol (U.S.)</i>	<i>Liq Vol (met)</i>	<i>Tray/ Ctn</i>	<i>Ctns/ Skid</i>	<i>Full bulk Skid</i>
21" X 10 1/2" X 2 3/8" H	251.8	1.09gal	4.13L	100	60	6,000



5001 Liner

<i>Dimensions</i>	<i>Dry Vol (cu. In.)</i>	<i>Liq Vol (U.S.)</i>	<i>Liq Vol (met)</i>	<i>Tray/ Ctn</i>	<i>Ctns/ Skid</i>	<i>Full bulk Skid</i>
21" X 10 1/2" X 2 3/8" H	300.3	1.30gal	4.92L	100	40	4,800

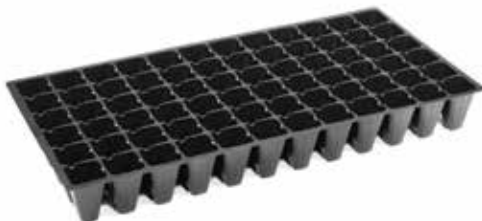

7201 Liner

<i>Dimensions</i>	<i>Dry Vol (cu. In.)</i>	<i>Liq Vol (U.S.)</i>	<i>Liq Vol (met)</i>	<i>Tray/ Ctn</i>	<i>Ctns/ Skid</i>	<i>Full bulk Skid</i>
21" X 10 1/2" X 2 3/8" H	235.6	1.02gal	3.86L	100	40	5,000



-LINE

10.5" X 21"

X-Line inserts and flats are the "original" and "traditional" — full-sized cells, bigger and deeper, for a more premium presentation in a 10.5" X 21" footprint. This functional product line incorporates all the good basics of product design with the performance standards required by premium growers. X-Line products offer a clear choice when differentiation is the goal. It is simple – deep-rooted plants look better longer and are easier to maintain at retail.





X-Line Products (10.5" X 21")



Half Flat

Dimensions	Dry Vol (cu. In.)	Liq Vol (U.S.)	Liq Vol (met)	Flat/ Ctn	Ctns/ Skid	Full bulk Skid
10 1/2" X 10 1/2" X 2 1/2"	275.63	1.19gal	4.51L	200	32	4,800

*Available with or without drainage holes



X-804 Deep

Dimensions	Dry Vol (cu. In.)	Liq Vol (U.S.)	Liq Vol (met)	In s / Ctn	Ctns/ Skid	Full bulk Skid
21" X 10 3/4" X 3 1/8" H	49.4	1.71 pt	809mL	100	32	3,200



X-NCR Tray

Dimensions	Dry Vol (cu. In.)	Liq Vol (U.S.)	Liq Vol (met)	Tray/ Ctn	Ctns/ Skid	Full bulk Skid
21" X 10 1/2" X 2 1/2" H	n/a	n/a	n/a	100	32	3,200

Additional X-Line products are available—go to www.summitplastic.com or contact your sales rep for more information.



SIZE *WISE*®

10" x 20"

Size Wise® products are built on a 10" x 20" footprint. Size Wise® inserts and flats offer the economy of scale with big design features – ample cell volume, excellent drainage slope and ideal height for precise label application.

Our Market Mate™ packs offer generous cell volumes, pop-up bottoms and a variety of handle insert points to fit your markets' need. Low Rider flats offer maximum space for label application and scanning at retail.

Select sizes of inserts come standard with tag slots, compatible with big-box retail, where required.





Size Wise Products (10" X 20")



Market Mate™ 4 (minimum run item)

Dimensions	Dry Vol (cu. In.)	Liq Vol (U.S.)	Liq Vol (met)	Pots/Ctn	Ctns/Skid	Full bulk Skid
------------	-------------------	----------------	---------------	----------	-----------	----------------

20" X 6 5/8" X 3 1/2" H

92.4

1.6qt

1.5L

150

60

n/a



Nu Tray 4-12 (Fits MM-4)

Dimensions	Trays/Ctn	Ctns/Skid	Full bulk Skid
------------	-----------	-----------	----------------

19 5/8" X 6 3/4" X 2" H

130

48

6,240



Market Mate™ 6

Dimensions	Dry Vol (cu. In.)	Liq Vol (U.S.)	Liq Vol (met)	Pack/Ctn	Ctns/Skid	Full bulk Skid
------------	-------------------	----------------	---------------	----------	-----------	----------------

20" X 10" X 3 1/2" H

135.0

2.33qt

2.2L

150

48

9,600

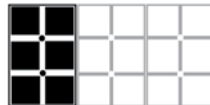

Accepts Handle Points:



Pop-up bottoms



SW Low 2CR 2SR

Dimensions	Trays/Ctn	Ctns/Skid	Full bulk Skid
------------	-----------	-----------	----------------

20" X 10" X 2 1/2" H

100

32

3,200

Size Wise Products (10" X 20")



Market Mate™ 8 (minimum run item)

Dimensions	Dry Vol (cu. In.)	Liq Vol (U.S.)	Liq Vol (met)	Pots/ Ctn	Ctns/ Skid	Full bulk Skid
19 1/4" X 10" X 3 1/2" H	127.0	2.2qt	2.1L	150	48	7,200

Accepts Handle Points:



Traditional



Market Mate 8 Tray

Dimensions	Trays/ Ctn	Ctns/ Skid	Full bulk Skid
19 1/4" X 10" X 2 1/4" H	100	27	2,700



Market Mate™ 9

Dimensions	Dry Vol (cu. In.)	Liq Vol (U.S.)	Liq Vol (met)	Pots/ Ctn	Ctns/ Skid	Full bulk Skid
10" X 10" X 3 1/2" H	202.1	3.5qt	3.3L	100	48	6,400

Accepts Handle Points:



Crescent Key-Hole Traditional



Pop-up bottoms

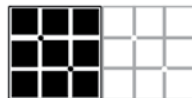

SW Open Flat

Dimensions	Trays/ Ctn	Ctns/ Skid	Full bulk Skid
20" X 10" X 2" H	n/a	n/a	1,800



Size Wise Products (10" X 20")



Market Mate™ 10 (minimum run item)

Dimensions	Dry Vol (cu. In.)	Liq Vol (U.S.)	Liq Vol (met)	Pots/ Ctn	Ctns/ Skid	Full bulk Skid
20" X 10" X 3 1/4" H	69.3	1.2qt	1.1L	200	48	12,800

Accepts Handle Points:



Traditional

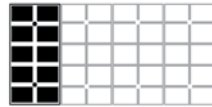

Market Mate 10 Tray (minimum run item)

Dimensions	Trays/ Ctn	Ctns/ Skid	Full bulk Skid
20" X 10" X 2 3/4" H	100	48	4,800



Market Mate™ 12

Dimensions	Dry Vol (cu. In.)	Liq Vol (U.S.)	Liq Vol (met)	Pots/ Ctn	Ctns/ Skid	Full bulk Skid
10" X 10" X 3 7/8" H	231	1.00gal	3.79L	100	48	4,800

Accepts Handle Points:



Key-Hole



Traditional



Pop-up bottoms

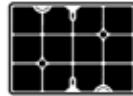

SW Open Flat

Dimensions	Trays/ Ctn	Ctns/ Skid	Full bulk Skid
20" X 10" X 2" H	n/a	n/a	1,800



Size Wise NCR Tray

Dimensions	Trays/ Ctn	Ctns/ Skid	Full bulk Skid
20" X 10" X 2" H	n/a	n/a	1,800

Size Wise Products (10" X 20")



Size Wise® 606 Deep

Dimensions	Dry Vol (cu. In.)	Liq Vol (U.S.)	Liq Vol (met)	Pots/ Ctn	Ctns/ Skid	Full bulk Skid
20" X 10" X 3 1/2" H	70.4	1.22 qt	1.15 L	100	32	3,200



SW 2SR

Dimensions	Trays/ Ctn	Ctns/ Skid	Full bulk Skid
20" X 10" X 3" H	100	32	3,200



SW Open Flat

Dimensions	Trays/ Ctn	Ctns/ Skid	Full bulk Skid
20" X 10" X 2" H	n/a	n/a	1,800



Size Wise® 804 Jumbo w/Tag Slots

Dimensions	Dry Vol (cu. In.)	Liq Vol (U.S.)	Liq Vol (met)	Pots/ Ctn	Ctns/ Skid	Full bulk Skid
20" X 10" X 4" H	61.3	1.06qt	1.0L	100	20	2,000



SW Low 3SR

Dimensions	Trays/ Ctn	Ctns/ Skid	Full bulk Skid
20" X 10" X 3" H	100	32	3,200



SW Open Flat

Dimensions	Trays/ Ctn	Ctns/ Skid	Full bulk Skid
20" X 10" X 2" H	100	n/a	1,800



Size Wise Products (10" X 20")

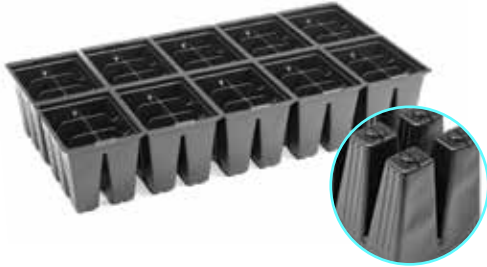

Size Wise® 1006 w/Tag Slots

Dimensions	Dry Vol (cu. In.)	Liq Vol (U.S.)	Liq Vol (met)	Pots/ Ctn	Ctns/ Skid	Full bulk Skid
20" X 10" X 4.25" H	40.4	1.40pt	662mL	100	3,200	2,400



SW 1006 Tray

Dimensions	Trays/ Ctn	Ctns/ Skid	Full bulk Skid
20" X 10" X 4.25" H	100	n/a	4,000



SW IM Open Flat

Dimensions	Trays/ Ctn	Ctns/ Skid	Full bulk Skid
20" X 10" X 2" H	n/a	n/a	1,800

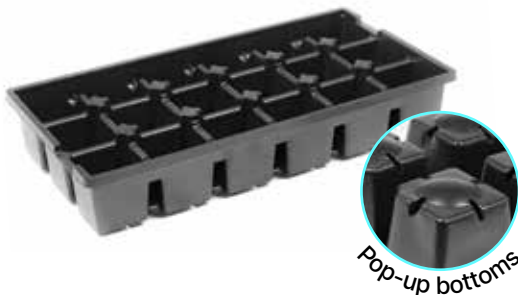

Size Wise® 18 Landscaper

Dimensions	Dry Vol (cu. In.)	Liq Vol (U.S.)	Liq Vol (met)	Pots/ Ctn	Ctns/ Skid	Full bulk Skid
20" X 10" X 3 3/8" H	429.7	1.86 gal	7.04 L	100	24	2,400

Pop-up bottoms



SLIM *WISE*™

7.25 x 20"

Slim Wise™ products are built on a 7 ¼" x 20" footprint. Slim Wise™ inserts and flats offer the economy of scale with big design features – ample cell volume, excellent drainage slope and ideal height for precise label application.

Slim Wise™ Market Mate™ packs offer ample cell volume for their size and a variety of handle points to fit your market.





Slim Wise Products (7.25" X 20")



Slim Wise Market Mate™ 6

Dimensions	Dry Vol (cu. In.)	Liq Vol (U.S.)	Liq Vol (met)	Pots/Ctn	Ctns/Skid	Full bulk Skid
20" X 7 1/4" X 3 3/4" H	103.9	1.6qt	1.7L	150	66	9,900



Accepts Handle Points:



Slim Wise Market Mate™ 6 Tray

Dimensions	Trays/Ctn	Ctns/Skid	Full bulk Skid
20" X 7 1/4" X 2" H	100	44	4,400



Slim Wise Open Flat

Dimensions	Trays/Ctn	Ctns/Skid	Full bulk Skid
20" X 7 1/4" X 2" H	100	44	4,400



Slim Wise Market Mate™ 304

Dimensions	Dry Vol (cu. In.)	Liq Vol (U.S.)	Liq Vol (met)	Pots/Ctn	Ctns/Skid	Full bulk Skid
20" X 7.25" X 4" H	106	1.8qt	1.7L	150	66	9,900



Accepts Handle Points:



Slim Wise Market Mate™ 304 Tray

Dimensions	Trays/Ctn	Ctns/Skid	Full bulk Skid
20" X 7.25" X 4" H	100	44	4,400

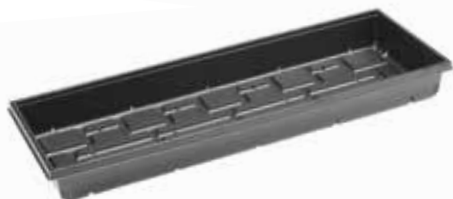

Slim Wise™ Open Flat

Dimensions	Trays/Ctn	Ctns/Skid	Full bulk Skid
20" X 7 1/4" X 2" H	100	44	4,400



Accepts Handle Points:



Crescent Key-Hole

Slim Wise Market Mate™ 9

Dimensions	Dry Vol (cu. In.)	Liq Vol (U.S.)	Liq Vol (met)	Pots/ Ctn	Ctns/ Skid	Full bulk Skid
10" X 7 1/4" X 3 1/4" H	161.7	2.8qt	2.6L	100	66	6,600

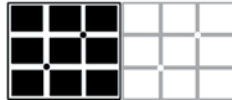

Slim Wise™ Open Flat



Dimensions	Trays/ Ctn	Ctns/ Skid	Full bulk Skid
20" X 7 1/4" X 2" H	100	44	4,400



Accepts Handle Points:



Crescent Key-Hole

Slim Wise Market Mate™ 12

Dimensions	Dry Vol (cu. In.)	Liq Vol (U.S.)	Liq Vol (met)	Pots/ Ctn	Ctns/ Skid	Full bulk Skid
10" X 7 1/4" X 3 3/4" H	140.43	2.43qt	2.29L	100	66	6,600



Slim Wise™ Open Flat



Dimensions	Trays/ Ctn	Ctns/ Skid	Full bulk Skid
20" X 7 1/4" X 2" H	100	44	4,400



Slim Wise Market Mate™ 406 Tray

Dimensions	Trays/ Ctn	Ctns/ Skid	Full bulk Skid
20" X 7.25" X 4" H	100	44	4,400

**Dimensions listed are full flat dimension; Volumes listed are for individual packs



Slim Wise Products (7.25" X 20")



Slim Wise™ 508 w/Tag Slots

Dimensions	Dry Vol (cu. In.)	Liq Vol (U.S.)	Liq Vol (met)	Pots/ Ctn	Ctns/ Skid	Full bulk Skid
20" X 7 1/4" X 3 1/2" H	57.8	1.00qt	mL	100	44	4,400

Slim Wise™ 508 Tray



Dimensions	Trays/ Ctn	Ctns/ Skid	Full bulk Skid
20" X 7 1/4" X 2" H	100	44	4,400

Slim Wise™ Open Flat



Dimensions	Trays/ Ctn	Ctns/ Skid	Full bulk Skid
20" X 7 1/4" X 2" H	100	44	4,400



Slim Wise™ 606

Dimensions	Dry Vol (cu. In.)	Liq Vol (U.S.)	Liq Vol (met)	Pots/ Ctn	Ctns/ Skid	Full bulk Skid
20" X 7 1/4" X 3 1/2" H	47.8	1.65pt	783mL	100	44	4,400

Slim Wise™ 606 Tray



Dimensions	Trays/ Ctn	Ctns/ Skid	Full bulk Skid
20" X 7 1/4" X 2" H	100	44	4,400

Slim Wise™ Open Flat



Dimensions	Trays/ Ctn	Ctns/ Skid	Full bulk Skid
20" X 7 1/4" X 2" H	100	44	4,400



RICE HULL CONTAINERS

Composed of natural rice hull fibers, this growing line of garden-friendly rice hull pots contain no heavy metal or oil-based products!

The “breathing” attributes of standard rice hull pots enable air and water to move through – as a result the root system and foliage are more vibrant with increased tolerance to stress from temperature and disease.

Unlike some other bio-options, Rice Hull containers will maintain their structure in most growing conditions for a year or more, and can run through automation equipment!

This renewable resource, is composed of waste from sustainable rice hull fibers, is plantable and 100% bio-degradable. Tested by Ball Horticultural Company and exclusively offered by Summit Plastic Company.





Rice Hull Containers



Rice Pot 3.5"

Dimensions	Dry Vol (cu. In.)	Liq Vol (U.S.)	Liq Vol (met)	Pots/Ctn	Ctns/Skid	Pots/Gaylord	Full bulk Skid
3 1/2" Dia X 3 5/16" H	22.9	12.7 oz	376mL	n/a	n/a	n/a	14,256



9cmH-6 Filling Tray (minimum run item)

Dimensions	Trays/Ctn	Ctns/Skid	Full bulk Skid
10 9/16" X 7" X 3 5/8" H	200	48	9,600

Special Feature(s): Standard round handle holes



9cmH-12 Filling Tray

Dimensions	Trays/Ctn	Ctns/Skid	Full bulk Skid
21" X 7" X 3 1/2" H	100	32	3,200



9cmH-18 Filling Tray

Dimensions	Trays/Ctn	Ctns/Skid	Full bulk Skid
21" X 10 1/2" X 3 1/2" H	50	48	2,400



Rice Pot 1 Pint Net

<i>Dimensions</i>	<i>Dry Vol (cu. In.)</i>	<i>Liq Vol (U.S.)</i>	<i>Liq Vol (met)</i>	<i>Pots/ Ctn</i>	<i>Ctns/ Skid</i>	<i>Pots/ Gaylord</i>	<i>Full bulk Skid</i>
3 1/2" Dia X 3 5/16" H	22.9	12.7 oz	376mL	n/a	n/a	n/a	14,256



SW 3.25 - 12 Tray (minimum run item)

<i>Dimensions</i>	<i>Trays/ Ctn</i>	<i>Ctns/ Skid</i>	<i>Full bulk Skid</i>
21" X 7" X 3 1/2" H	100	32	3,200



SW 3.25 - 18 Tray (minimum run item)

<i>Dimensions</i>	<i>Trays/ Ctn</i>	<i>Ctns/ Skid</i>	<i>Full bulk Skid</i>
21" X 7" X 3 1/2" H	100	32	3,200



Rice Hull Containers



4" Rice Pot

<i>Dimensions</i>	<i>Dry Vol (cu. In.)</i>	<i>Liq Vol (U.S.)</i>	<i>Liq Vol (met)</i>	<i>Pots/ Ctn</i>	<i>Ctns/ Skid</i>	<i>Pots/ Gaylord</i>	<i>Full bulk Skid</i>
4" Dia X 3 11/16" H	29.0	1.00pt	473ml	n/a	n/a	n/a	8,800



10cmT-6 Filling Tray (minimum run item)

<i>Dimensions</i>	<i>Trays/ Ctn</i>	<i>Ctns/ Skid</i>	<i>Full bulk Skid</i>
11 7/8" X 8" X 3 3/4" H	200	44	8,800



10cmT-10 Filling Tray

<i>Dimensions</i>	<i>Trays/ Ctn</i>	<i>Ctns/ Skid</i>	<i>Full bulk Skid</i>
19 3/4" X 8" X 3 3/4" H	100	44	4,400



4.5" Rice Pot

Dimensions	Dry Vol (cu. In.)	Liq Vol (U.S.)	Liq Vol (met)	Pots/Ctn	Ctns/Skid	Pots/Gaylord	Full bulk Skid
4 1/2" Dia X 4 1/8" H	36.1	1.25pt	591mL	n/a	n/a	n/a	5,832



12cmH-8 Filling Tray

Dimensions	Trays/Ctn	Ctns/Skid	Full bulk Skid
18 1/2" X 9" X 4 1/8" H	100	32	3,600



12cmH-8 Spaced Filling Tray

Dimensions	Trays/Ctn	Ctns/Skid	Full bulk Skid
20" X 10" X 4 1/8" H	100	32	3,200



12cmH-12 Filling Tray (Minimum run item)

Dimensions	Trays/Ctn	Ctns/Skid	Full bulk Skid
18 1/2" X 13 3/4" X 4 1/8" H	100	24	2,400



12cmH-15 Filling Tray (Minimum run item)

Dimensions	Trays/Ctn	Ctns/Skid	Full bulk Skid
23 5/16" X 13 3/4" X 4" H	50	30	1,800



Rice Hull Containers



5" Rice Pot

<i>Dimensions</i>	<i>Dry Vol (cu. In.)</i>	<i>Liq Vol (U.S.)</i>	<i>Liq Vol (met)</i>	<i>Pots / Ctn</i>	<i>Ctns / Skid</i>	<i>Pots / Gaylord</i>	<i>Full bulk Skid</i>
5 5/16" Dia X 4" H	60.6	1.05qt	994mL	n/a	n/a	n/a	5,248



13cmH-6 Filling Tray (minimum run item)

<i>Dimensions</i>	<i>Trays / Ctn</i>	<i>Ctns / Skid</i>	<i>Full bulk Skid</i>
15 1/4" X 10 1/4" X 5" H	100	36	3,600



13cmH-8 Filling Tray

<i>Dimensions</i>	<i>Trays / Ctn</i>	<i>Ctns / Skid</i>	<i>Full bulk Skid</i>
20" X 10" X 5" H	50	48	2,400



6" Rice Pot

<i>Dimensions</i>	<i>Dry Vol (cu. In.)</i>	<i>Liq Vol (U.S.)</i>	<i>Liq Vol (met)</i>	<i>Pots/ Ctn</i>	<i>Ctns/ Skid</i>	<i>Pots/ Gaylord</i>	<i>Full bulk Skid</i>
6" Dia X 4 1/4" H	75.7	1.31qt	1.24L	n/a	n/a	n/a	3,332



15cmL-6 Filling Tray

<i>Dimensions</i>	<i>Trays/ Ctn</i>	<i>Ctns/ Skid</i>	<i>Full bulk Skid</i>
18" X 11 1/2" X 4 1/2" H	50	42	2,100



16cmT-3 Filling Tray

<i>Dimensions</i>	<i>Trays/ Ctn</i>	<i>Ctns/ Skid</i>	<i>Full bulk Skid</i>
18 7/8" X 6 5/16" X 4 1/2" H	100	32	5,600



6.5" Rice Pot

<i>Dimensions</i>	<i>Dry Vol (cu. In.)</i>	<i>Liq Vol (U.S.)</i>	<i>Liq Vol (met)</i>	<i>Pots/ Ctn</i>	<i>Ctns/ Skid</i>	<i>Pots/ Gaylord</i>	<i>Full bulk Skid</i>
6 1/2" Dia X 6 1/2" H	162.3	2.81qt	2.66L	n/a	n/a	n/a	2,450

Visit us at: summitplastic.com

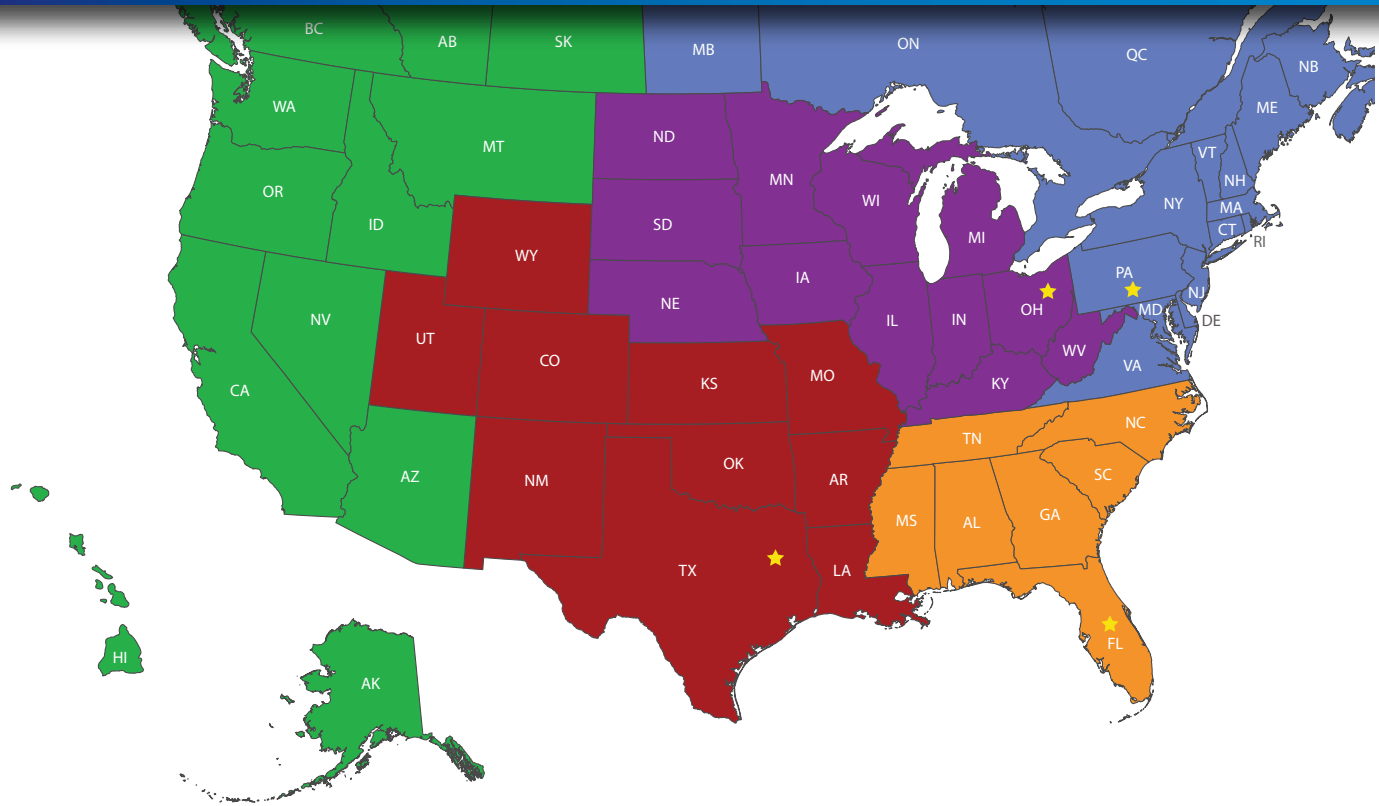

Mike Gibbs
Southeast Sales Manager
Mikegibbs@summitplastic.com



Wayne Thiel
Northeast Sales Manager
Waynethiel@summitplastic.com



Darden Jones
Southwest Sales Manager
Dardenjones@summitplastic.com



Russell Crookston
Western Sales/Graphics Manager
Russell@summitplastic.com



Rob Gumpf
VP Sales
Robertgumpf@summitplastic.com



Robin Buckridge
Mid-West Sales Manager
Robin@summitplastic.com



800.814.3496